



# Product Specification

Product Name	<u>SK6812 LED STRIP</u>
Product Number	<u>HTD-6812XX-5V</u>
Version Number	<u>V1.0</u>
Page	<u>8</u>

**CE**

**RoHS**

## Product description

SK6812 LED Strip use the FPCB (flexible printed circuit board) to be assembly circuit boards, use SMD LED lights and components to be assembled, so that the thickness of the product only just like, Occupy a small space, and can be arbitrarily cut, FPC is soft material, can random winding, and wound freely movable in three-dimensional space without breaking, suitable for irregular place and narrow space of places to install, but also as any possible bending, suitable for advertising, decorative lighting, any combination of the kinds of patterns, LED Chip is built-in IC, then the components is less , pixels can be high, can make attractive appearance, and so on.

IC is designed with one data line, two power lines, 256 gray scale, high brightness, fast data transfer, fast screen refresh, etc. , with the controller, you can achieve monochrome, gradient, water , horse racing, text, numbers, chase, English, pictures, animations, video, any effect, and so on.

Products using DC5V voltage to power supply, high safety factor, using the import led chip to be the light source , high brightness, light fade is small, maintenance-free, long lifespan , energy-saving and environmental protection, based on the above characteristics, More and more people choose led strip as lighting , decoration product .

## Product Image



## Product Features

Adopt international leading manufacturer's chips, high brightness , width angle, color consistency, and stable performance. Each lamp beads form a loop, can be arbitrarily cut according to the needs of the length of the loop, without damaging other parts Convenient to Fix and install, flexible cutting operation make the construction simple, ultra-thin design, low temperature light source, make the selection for the auxiliary material more flexible on installation Energy saving, high brightness, low heat, low energy consumption, Clean, and beautiful;Use DC5V to power supply, more safe on using Protection Rating: IP62 IP65 IP67 IP68, use range is wide Small, multi-colored, no radiation, high shock resistance, is a new generation of green high-tech products

## Product Warranty

Warranty is 2 Years

## Applications

- City skyline lighting (villas, advertising wall signs, Christmas decorative landscape)
- Irregular design of body decoration (shopping malls, hotels, nightclubs, polygonal wall KTV establishments ceiling cavity design)
- Public lighting lighting (schools, libraries, hospitals, airports, subway stations, railway stations)
- Furniture dark groove trim (door, bar, wine cabinet, wardrobe, TV cabinets, etc.)
- Automotive beauty (body, underbody, wheelbarrow balanced car, etc.)

## Project Case



# LED Strip dimension

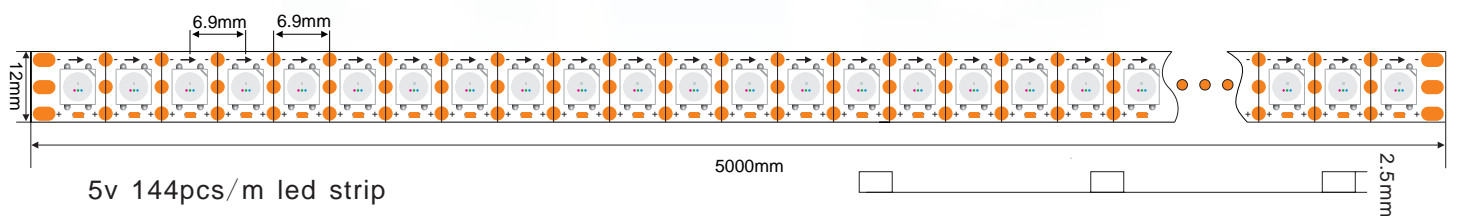
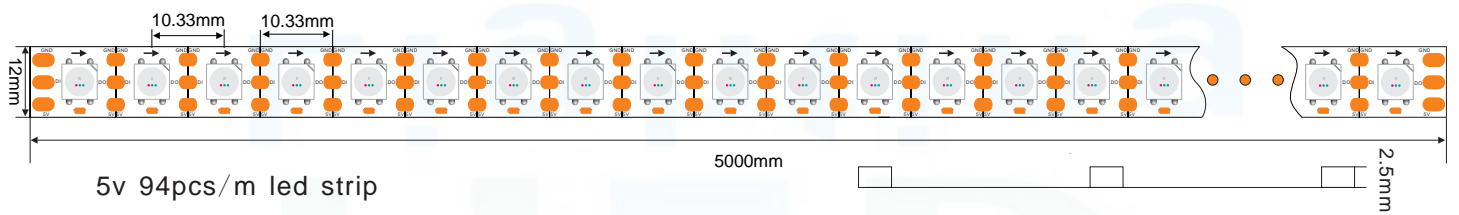
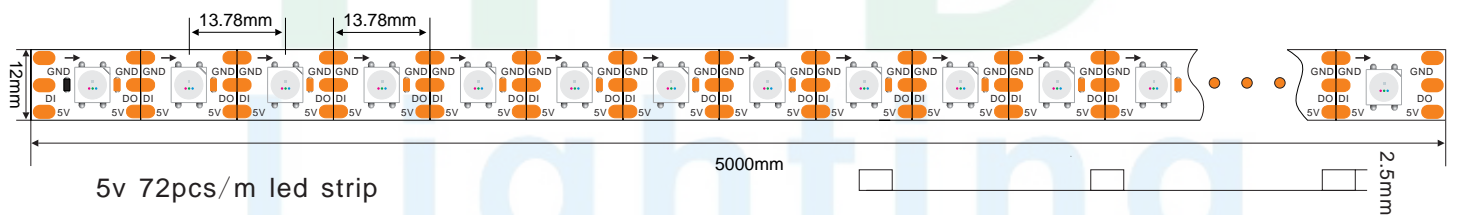
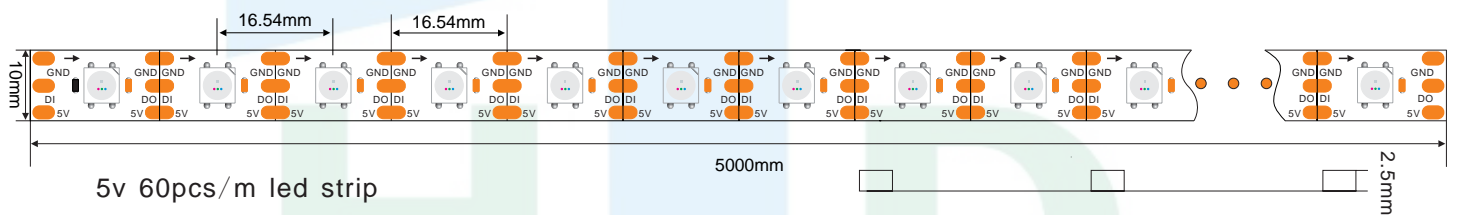
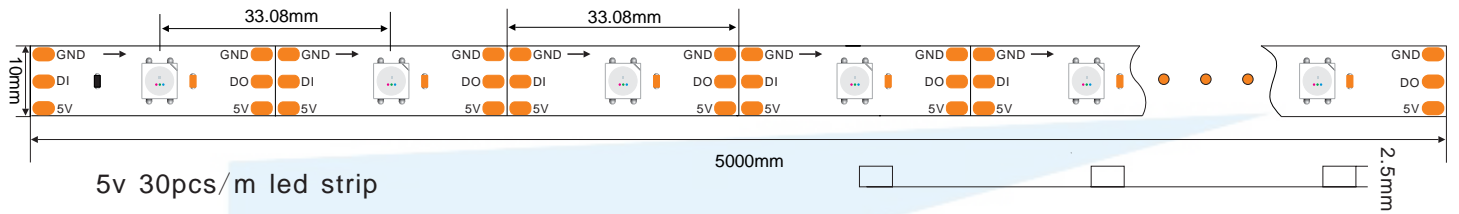

# Specifications

## 1 meter led strip Specifications

Specifications	Voltage	Power	Angle	IP Rating	Color	Color Temperature		Ra		Lumen			Life
						Min	Max	Min	Max	Min	Average	Max	
HTD-6812X30X-5V	5V	9W	120	IP62、IP67 IP65、IP68		2800K	10000K	Ra>70	Ra>80	R:36LM G:90LM B:30LM W:510LM WW:510LM	R:45LM G:120LM B:45LM W:540LM WW:540LM	R:54LM G:150LM B:48LM W:600LM WW:600LM	50000H
HTD-6812X60X-5V	5V	18W	120	IP62、IP67 IP65、IP68		2800K	10000K	Ra>70	Ra>80	R:72LM G:180LM B:60LM W:1020LM WW:1020LM	R:90LM G:240LM B:90LM W:1080LM WW:1080LM	R:108LM G:300LM B:96LM W:1200LM WW:1200LM	50000H
HTD-6812X72X-5V	5V	21.6W	120	IP62、IP67 IP65、IP68		2800K	10000K	Ra>70	Ra>80	R:86LM G:216LM B:72LM W:1224LM WW:1224LM	R:108LM G:288LM B:108LM W:1296LM WW:1296LM	R:129LM G:360LM B:115LM W:1440LM WW:1440LM	50000H
HTD-6812X96X-5V	5V	28.8W	120	IP62、IP67 IP65、IP68		2800K	10000K	Ra>70	Ra>80	R:115LM G:288LM B:96LM W:1632LM WW:1632LM	R:144LM G:384LM B:144LM W:1782LM WW:1782LM	R:172LM G:480LM B:147LM W:1920LM WW:1920LM	50000H
HTD-6812X144X-5V	5V	43.2W	120	IP62、IP67 IP65、IP68		2800K	10000K	Ra>70	Ra>80	R:172LM G:432LM B:144LM W:2448LM WW:2448LM	R:216LM G:576LM B:216LM W:2592LM WW:2592LM	R:259LM G:720LM B:230LM W:2880LM WW:2880LM	50000H

Note, the above optical parameters, models X represents optionally, color, water level, the index display. Etc., please indicate clearly when ordering.

Light decay parameters, test the ambient temperature of 25 degrees, plus or minus 3 degrees

testing time	light fades rate
500H	0%
1000H	0%
2000H	0.5%
4000H	1.2%
6000H	2%

Note, due to the particularity LED product manufacturing process, technical parameters above reflect only the statistics, do not necessarily correspond to the actual parameters of each product, the product may differ from the actual parameters of the above parameters

# Strip cut schematic

Scissors to cut at the mouth

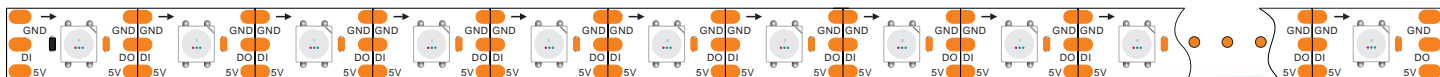

# LED STRIP wiring diagram

When using lights outdoors, be sure to do waterproof connectors, waterproof power to do well



The heat shrink tubing set into the light band, and then the lights welding firm

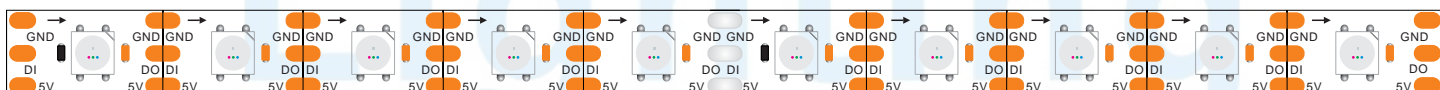

Two weld will shrink tubing to move the welding and weld completely wrap

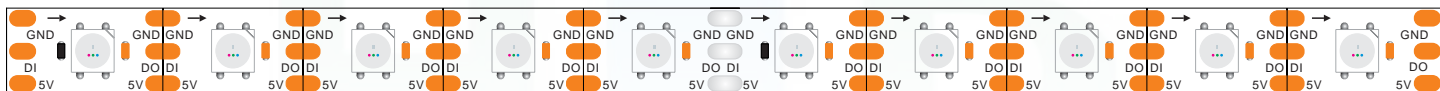

After leaving a good heat shrink tubing, heat shrinkable tube aligned hairdryer to blow completely encased like a light bar

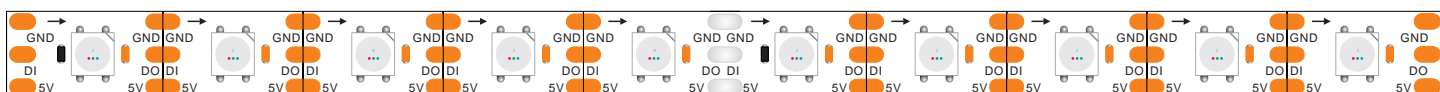

# LED Strip wiring diagram

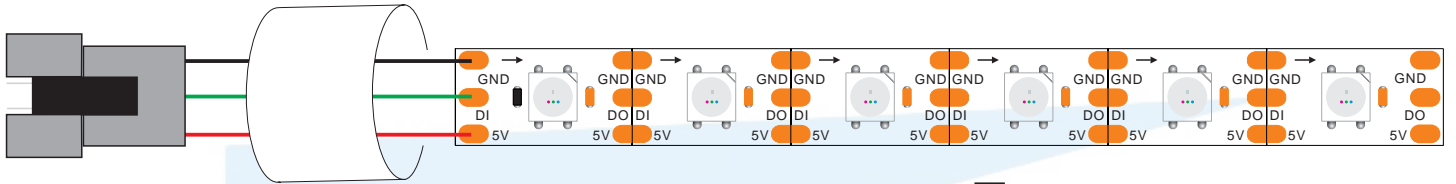

The red, green, yellow and black wires soldered to the lamp terminals tape, then put shrink heat shrink tube

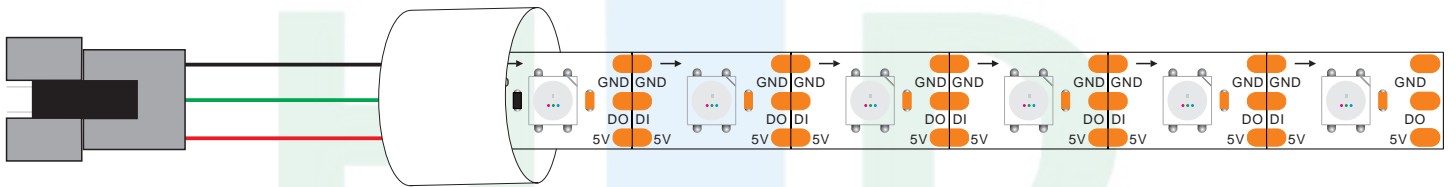

Adjustment shrink tubing, solder joints completely shrink tube

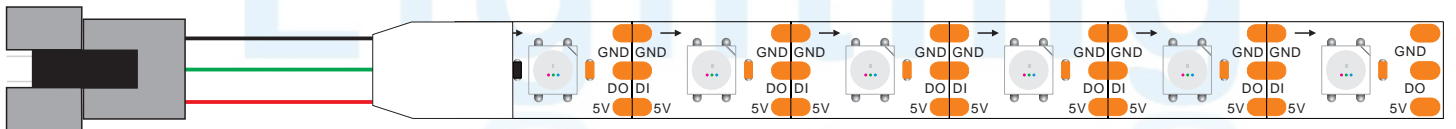

After adjustment shrink tube with hot hair dryer blowing shrink sleeve, shrink wrap the joints until completely

# Installation wiring diagram

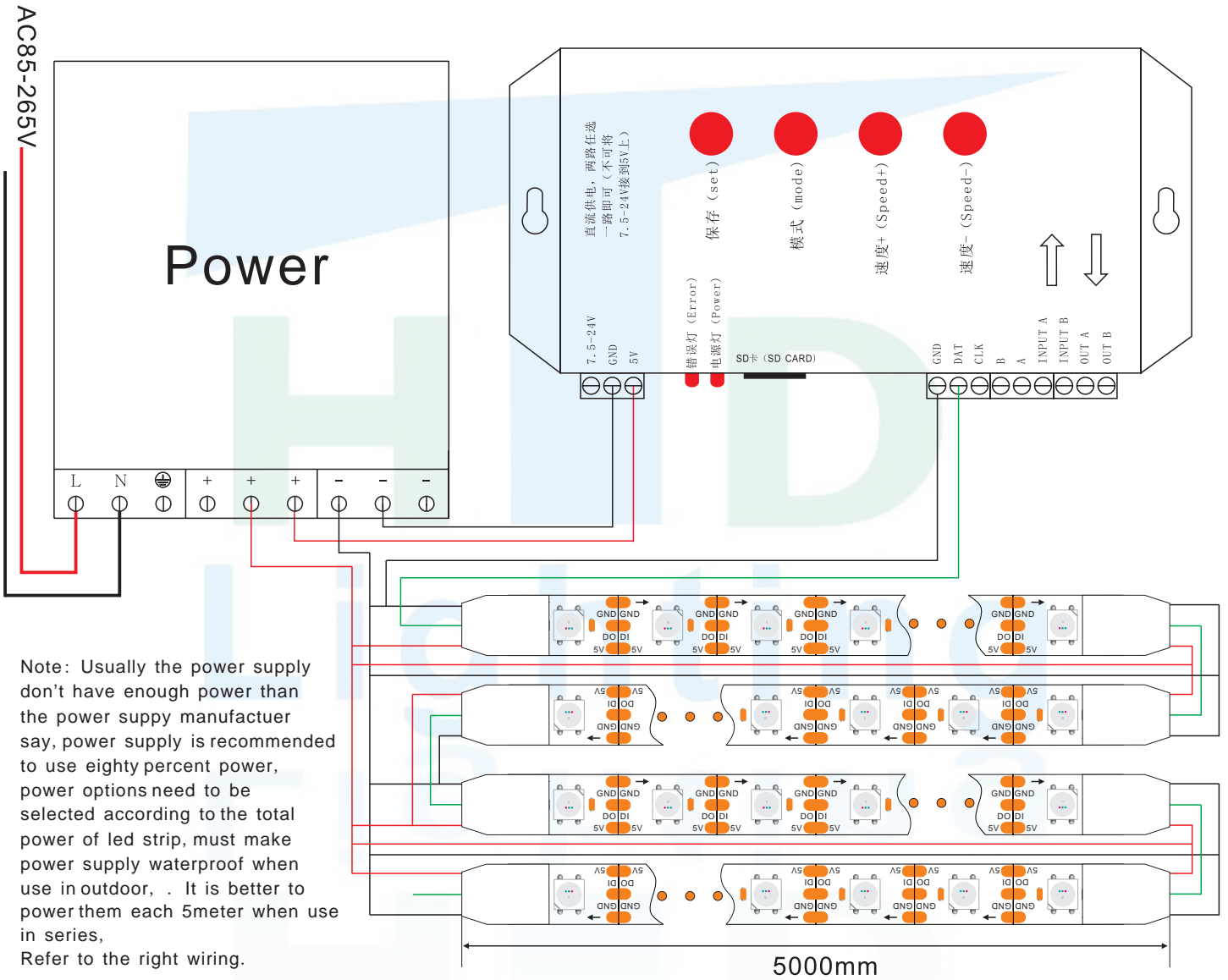

## IP62, IP65 the installation diagram



Clean surface debris , ensure the strip surface clean



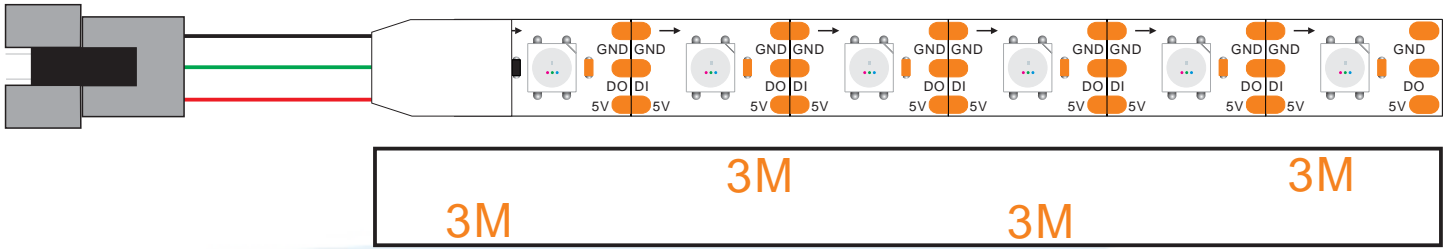

Pull the 3m paper out of the back of led strip

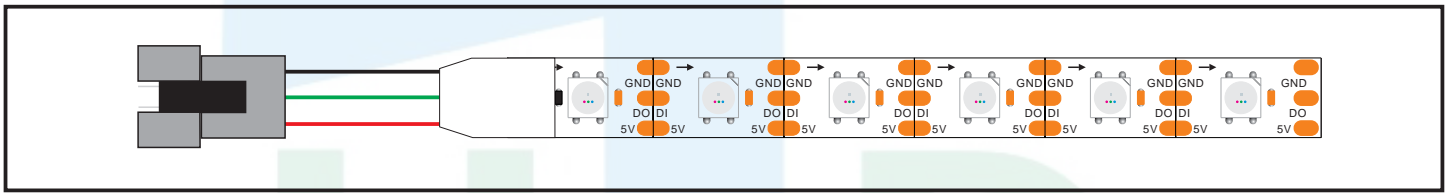

The lights straighten directly fixed to the mounting position

## IP67, IP68 the installation diagram



Clean surface debris , ensure the strip surface clean

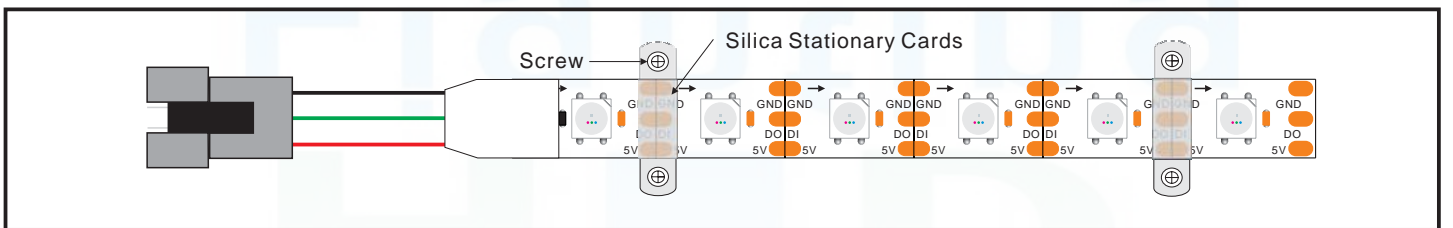

Put the led strip on install place , use screw to fixed , each meter need to use 2 silicone snap

## Notes

- Please read the specifications and precautions carefully before installation
- Please do not use nails or sharp instruments to install led strip on the object, use double-sided tape or glue or wall mounted on plywood
- Fixed led strip, you can not use acidic glue, it is recommended to use a neutral glue.
- This product is a constant voltage DC5V, make sure Power is right before installation, after installation, check the wiring is correct or not , so that avoid the product been burned
- This product is recommended use in parallel. when the length is more than five meters, the tail so be power to ensure the brightness is enough or uneven