



LED Flexible Strip HTD-RGT-2835-D240 Double row

Description of products:

HTD-RGT-2835-D240

- Constitute by FPC, SMD3528 240LEDs(double row) per meter and UV resistant silicone resin.
- The LED beam is 125-135° flood lighting, without the shadow, high brightness in 18-24lm/LED, low therm resistance, low Light failure, in a poor environment can good work.
- 48W/1M, the working voltage is DC24V.
- Optional: IP20/IP65/IP68 waterproof level. Warranty optinal 1/2/3/5 years.
- Main applications:
 - Commercial and residential decoration
 - Under-counter lighting
 - Media illumination
 - Large area backlighting
 - Small to medium channel letters
 - Point-of-sale displays
 - Used for Neon or tubes replacement, etc.



*Tips:

- When we computing power should retain 20% of the allowance.
- Up to 5 Meters HTD-RGT-2835-D240 to use in one parallel. Screw holes on both ends to fixed, convenient and accurate.
- Advice that both ends connect DC24V power if must need 10M a string connect power supply, achieve the best use effect.



Product Chart:





LED Flexible Strip HTD-RGT-2835-D240 Double row

Product Dimension Chart(Tube or IP68 width need add 2-4mm):

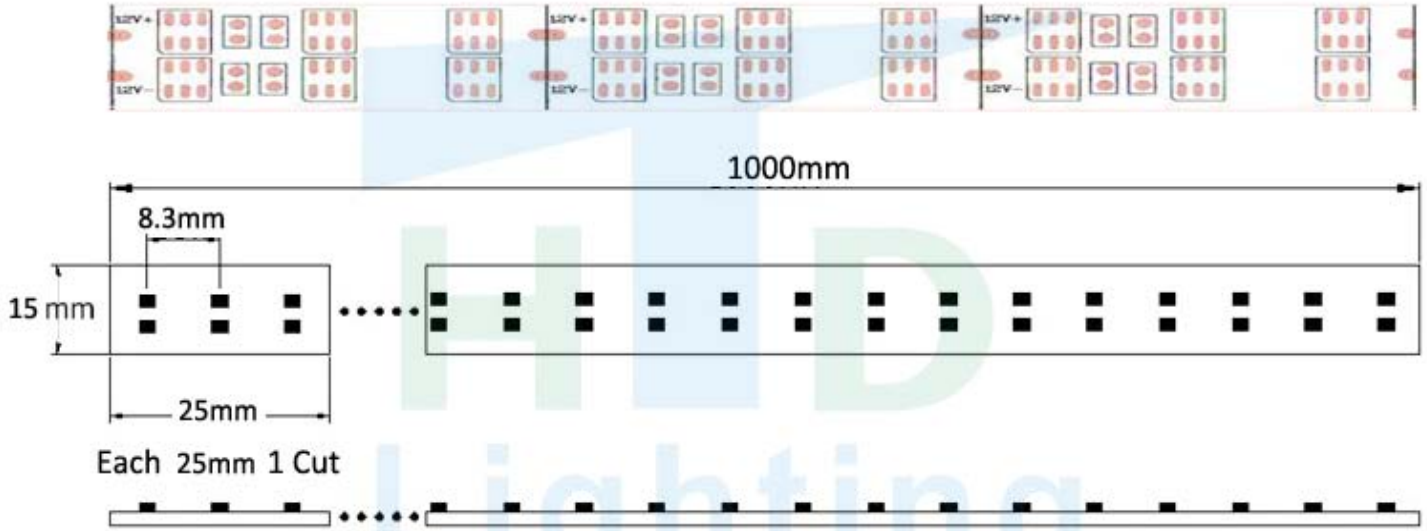

***Note: IP20 Height is 1.5mm/IP65 Height is 2.5mm/IP68 Height is 3.5mm**

Photometric characteristics & Main material:

Item No.	CCT	LED quantity	luminous flux (LM)	CRI	LED SPEC	PCB type	Main component
HTD-RGT-2835-D240(Double row)	4500K	240	4320-5760lm	>78-80	SMD 2835	Flexible FPC	FPC+LED (IP65: Silicone)

Basic parameters:

Item	Parameters	Units
Working voltage	DC24	V
Working power	48	W
Working temperature	-40~60	°C
IP grade	IP20/IP65/IP68	*
Optional light color	W/WW/CW/R/G/B/P...Can customize color	*
Beam Angle	≥120°	*
Light Source Lifespan	≥50000	hrs
Dimensions(Look above Dimension Chart)	1000×15×1.5/2.5/3.5(IP20/IP65/IP68)	mm
Net Weight/5M/Roll IP20	0.128	Kg

Connection mode (see below)

A/.DC24V transformer connect 220V/110V AC voltage;

B/.And then,LED strips connection DC24V output transformer.



LED Flexible Strip HTD-RGT-2835-D240 Double row

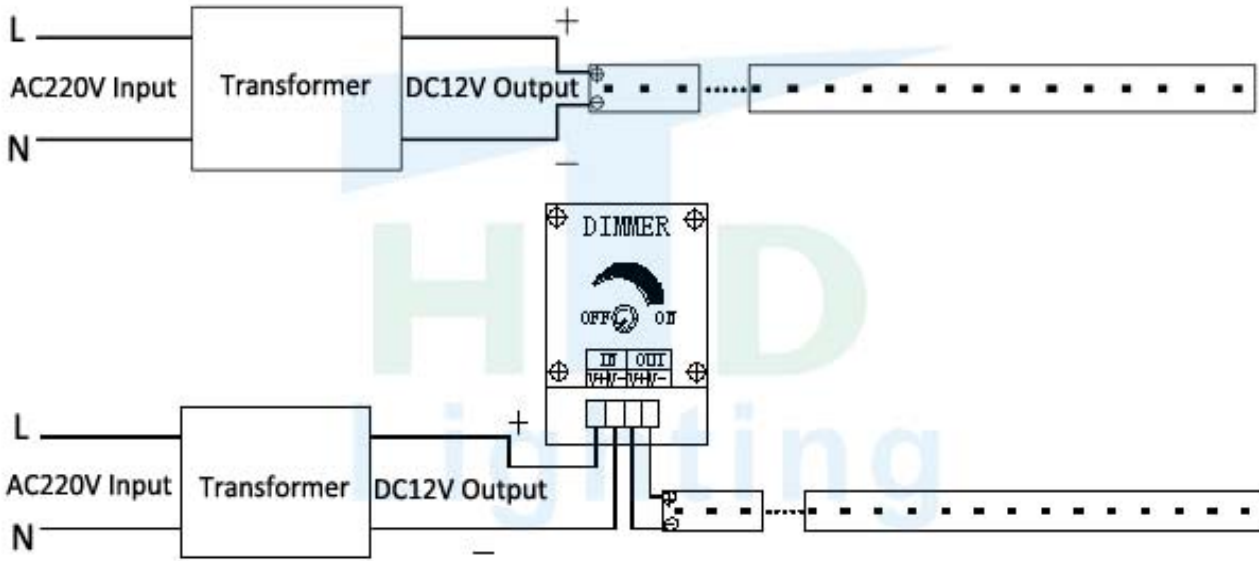

***LED module/Pixel light/Strip light Single color wiring diagram**

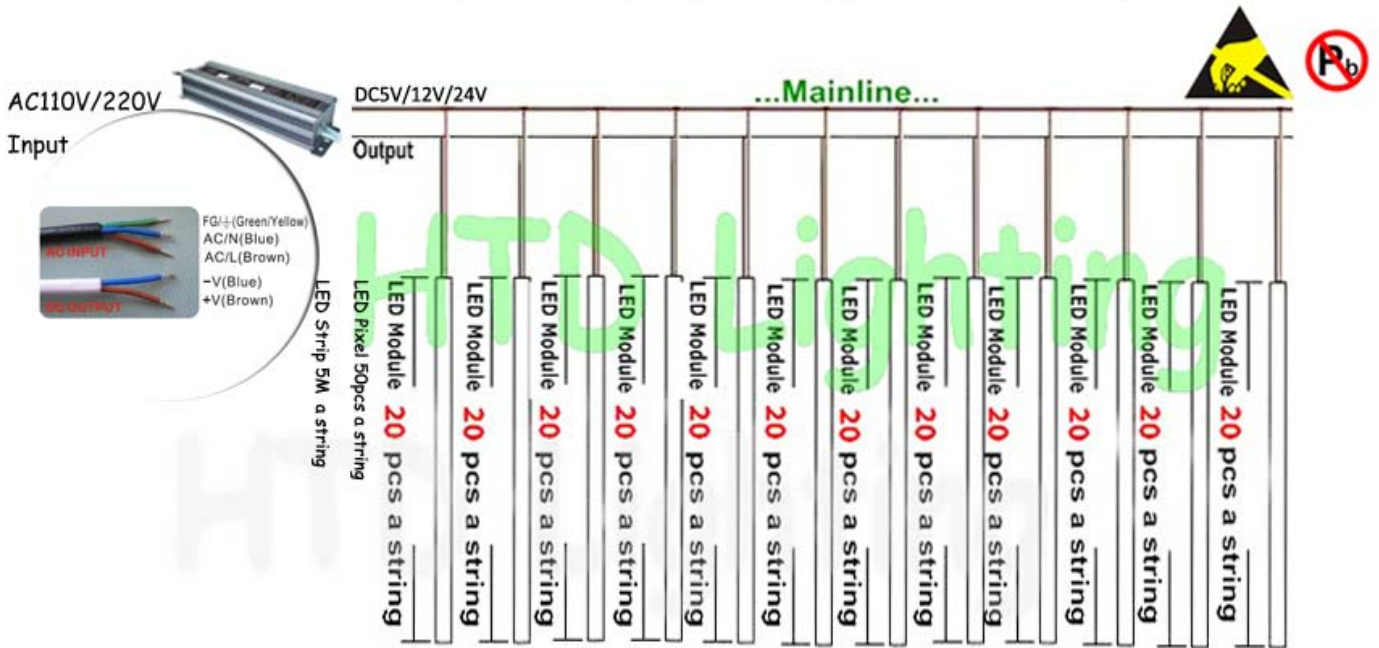

*This product the most can tandem connection 20pcs module/50pcs pixel/5M strip, Prohibited beyond tandem connection. The thickness of power should according to actual possible present maximum current, the power of products, wiring length (suggest not exceeding 6M) and low voltage transmission line voltage drop. In measuring power use number of circumstances, should retain 20% of the allowance.

*(Important) Ensure that both ends connect power, achieve the best use effect. The module MAX 40pcs/string, Pixel MAX 100pcs/string, Strip MAX 10M/String.

***Installation guide**

1. Product labeled 3M two-side glue, stick in the need to install the position (please clean surface) can;
2. Installation using fixed installation clipper to buckle. 1 meter using 2 clippers and four M3 screws (Some styles just 2pcs).

LED Flexible Strip HTD-RGT-2835-D240 Double row

Connect accessories:

Connect accessories optional:

IP20:1 to 1/1 to 4 and Connector with wire

IP65:Just 1 to 1 and Connector with wire

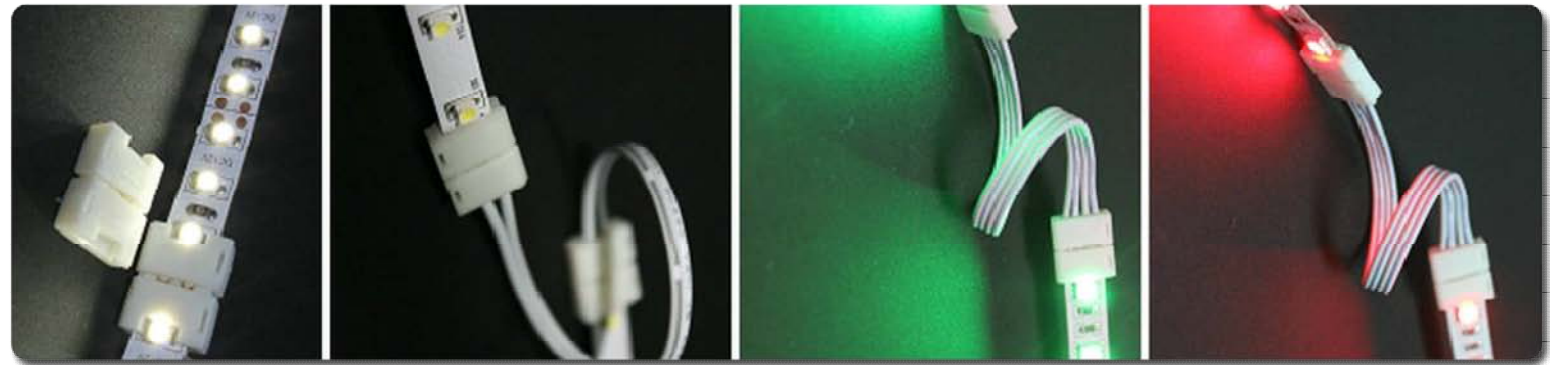
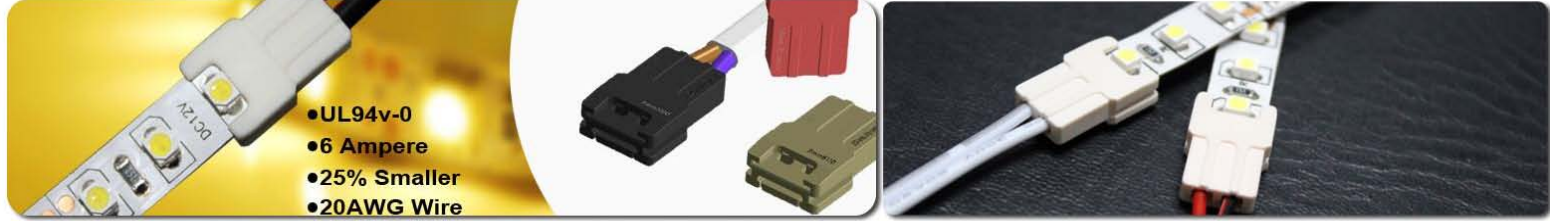

IP20

Non-Waterproof



IP65

Epoxy glue



IP68

Soft silicon tube mixed epoxy glue



LED Strip light identify



LED Flexible Strip HTD-RGT-2835-D240 Double row

Package:

Conventional packing: every 5M/Roll

Carton size: 45cm*25cm*32cm.

IP20---0.128kg/roll,45Rolls/Carton/7.76kg

IP68---0.451kg/roll,25Rolls/Carton/11.25kg

IP65---0.256kg/roll,30Rolls/Carton/7.68kg

*Tips: Above package allow have 10% error

Tape feed roller



5M Led strip per roll





5M Led strip



Anti-static aluminum foil bag

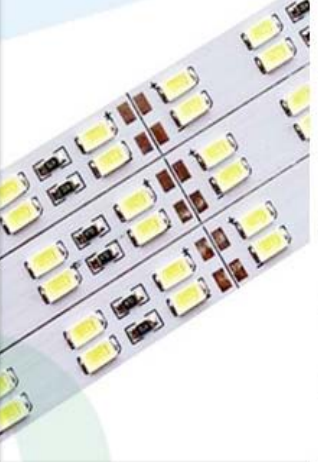

***Other style of LED Flexible strip recommend**

<p>HTD-RGT-3528-T360</p> 	<p>HTD-RGT-335-SD240</p> 	<p>HTD-RGT-3528-F480</p> 	<p>HTD-RGT-2538-D120</p> 
<p>HTD-RGT-3528-240</p> 	<p>HTD-RGT-5730-120</p> 	<p>HTD-RGT-3528-A240</p> 	<p>HTD-RGT-5050-D120</p> 