

LED Flexible Strip HTD-RGT-3014-120

Description of products:

HTD-RGT-3014-120

- Constitute by FPC, SMD2835 120LEDs per meter and UV resistant silicone resin.
- The LED beam is 125-135° flood lighting, without the shadow, high brightness in 12-14lm/LED, low therm resistance, low Light failure, in a poor environment can good work.
- 12W/1M, the working voltage is DC12V/24V.
- Optional: IP20/IP65/IP68 waterproof level. Warranty optinal 1/2/3/5 years.
- Main applications:
 - Commercial and residential decoration
 - Under-counter lighting
 - Media illumination
 - Large area backlighting
 - Small to medium channel letters
 - Point-of-sale displays
 - Used for Neon or tubes replacement, etc.

*Tips:

- When we computing power should retain 20% of the allowance.
- Up to 5 Meters HTD-RGT-3014-120 to use in one parallel. Screw holes on both ends to fixed, convenient and accurate.
- Advice that both ends connect DC12V power if must need 10M a string connect power supply, achieve the best use effect.



Product Chart:





— Concentrate on every lamp —

LED Flexible Strip HTD-RGT-3014-120

Product Dimension Chart(IP68 width is12mm):

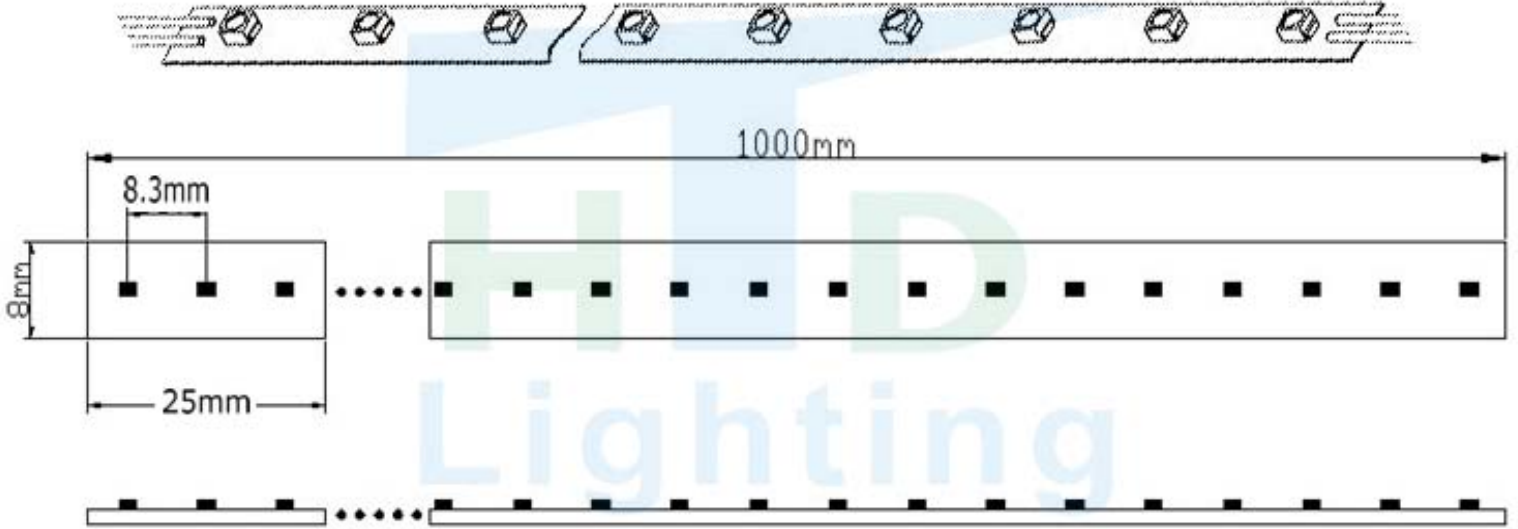

Photometric characteristics & Main material:

Item No.	CCT	LED quantity	luminous flux (LM)	CRI	LED SPEC	PCB type	Main component
HTD-RGT-3014-120	4500K	120	1440-1640lm	>78-80	SMD 3014	Flexible FPC	FPC+LED

Basic parameters:

Item	Parameters	Units
Working voltage	DC12/24	V
Working power	12	W
Working temperature	-40~60	°C
IP grade	IP20/IP65/IP68	*
Optional light color	W/WW/CW/R/G/B/P...Can match color.	*
Beam Angle	≥120°	*
Light Source Lifespan	≥50000	hrs
Dimensions(Look above Dimension Chart)	1000×8×1.5/2.5/3.5(IP20/IP65/IP68)	mm
Net Weight/5M/Roll IP20	0.128	Kg

Connection mode (see below)

A/.DC12V transformer connect 220V/110V AC voltage;

B/.And then,LED strips connection DC12V/24V output transformer.



LED Flexible Strip HTD-RGT-3014-120

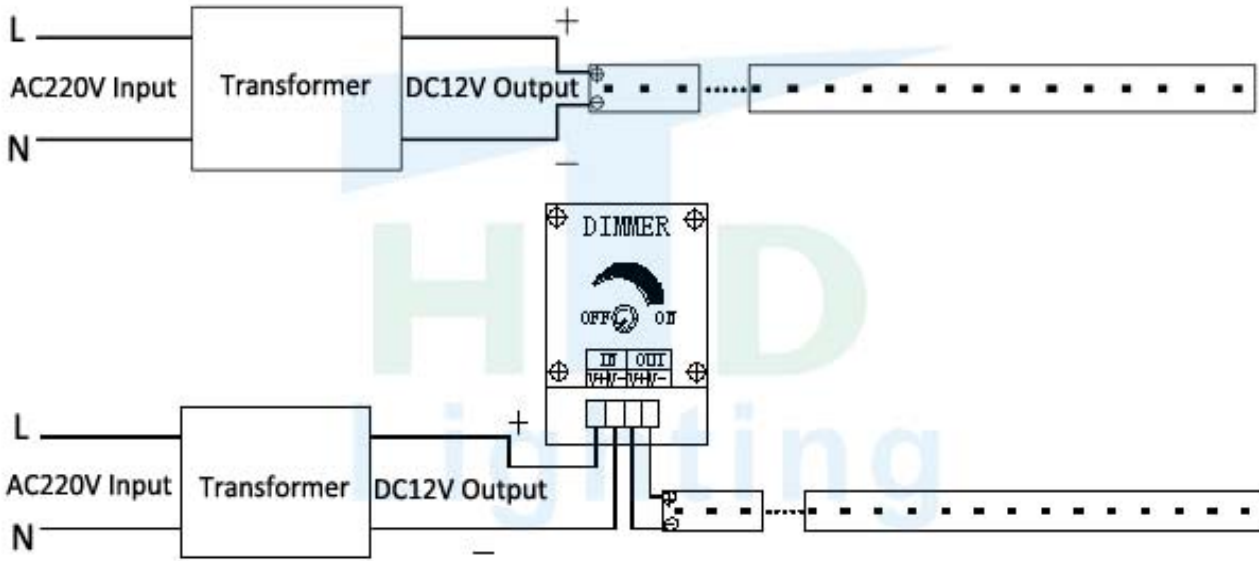

***LED module/Pixel light/Strip light Single color wiring diagram**

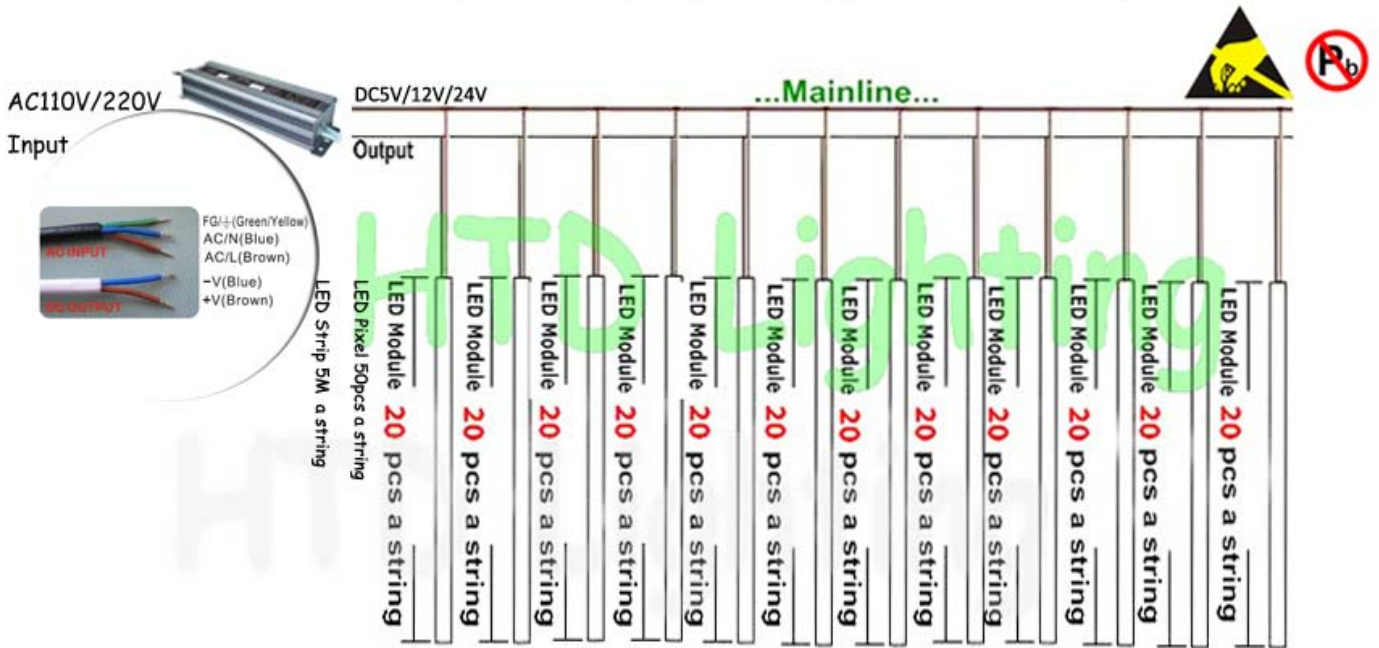

*This product the most can tandem connection 20pcs module/50pcs pixel/5M strip, Prohibited beyond tandem connection. The thickness of power should according to actual possible present maximum current, the power of products, wiring length (suggest not exceeding 6M) and low voltage transmission line voltage drop. In measuring power use number of circumstances, should retain 20% of the allowance.

*(Important) Ensure that both ends connect power, achieve the best use effect. The module MAX 40pcs/string, Pixel MAX 100pcs/string, Strip MAX 10M/String.

***Installation guide**

1. Product labeled 3M two-side glue, stick in the need to install the position (please clean surface) can;
2. Installation using fixed installation clipper to buckle. 1 meter using 2 clippers and four M3 screws (Some styles just 2pcs).

LED Flexible Strip HTD-RGT-3014-120

Connect accessories:

Connect accessories optional:

IP20:1 to 1/1 to 4 and Connector with wire

IP65:Just 1 to 1 and Connector with wire

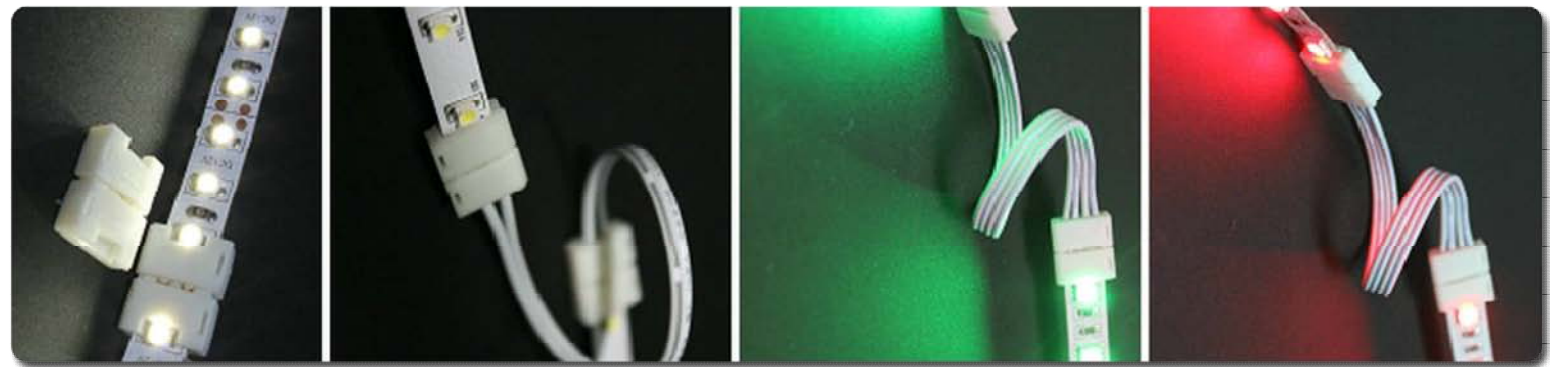
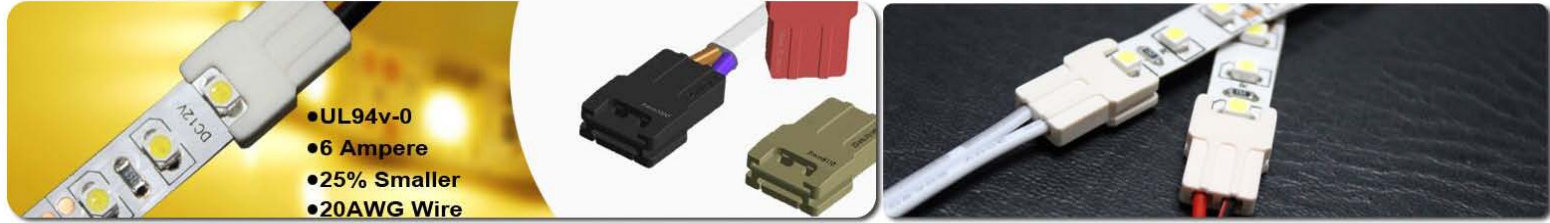

IP20

Non-Waterproof



IP65

Epoxy glue



IP68

Soft silicon tube mixed epoxy glue



LED Strip light identify



LED Flexible Strip HTD-RGT-3014-120

Package:

Conventional packing: every 5M/Roll

Carton size: 45cm*25cm*32cm.

IP20---0.128kg/roll,45Rolls/Carton/7.76kg

IP68---0.451kg/roll,25Rolls/Carton/11.25kg

IP65---0.256kg/roll,30Rolls/Carton/7.68kg

*Tips: Above package allow have 10% error

Tape feed roller

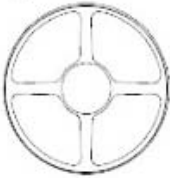

5M Led strip per roll

5M Led strip

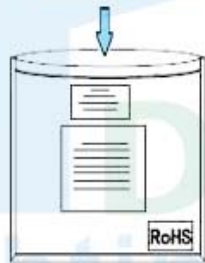

Anti-static aluminum foil bag

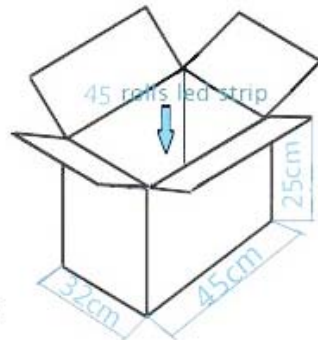

***Other kind of LED Flexible strip recommend**

HTD-RGT-2835-120



HTD-RGT-5050-60



HTD-RGT-5730-112



HTD-RGT-5024IC
-DMX72RGB



HTD-RGT-3014-240



HTD-RGT-5050-60RGBW



HTD-RGT-2835-S60



HTD-RGT-50144IC
-144RGB

